

型号

ER-3301

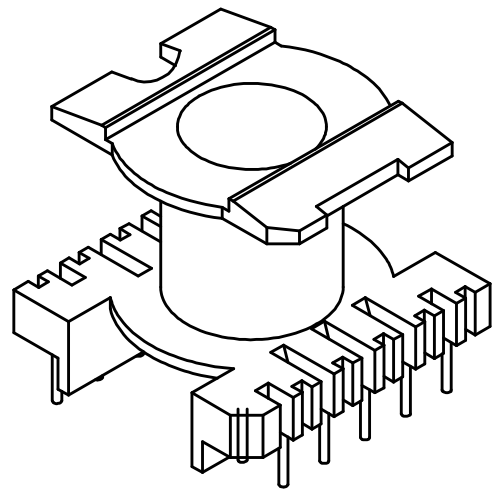
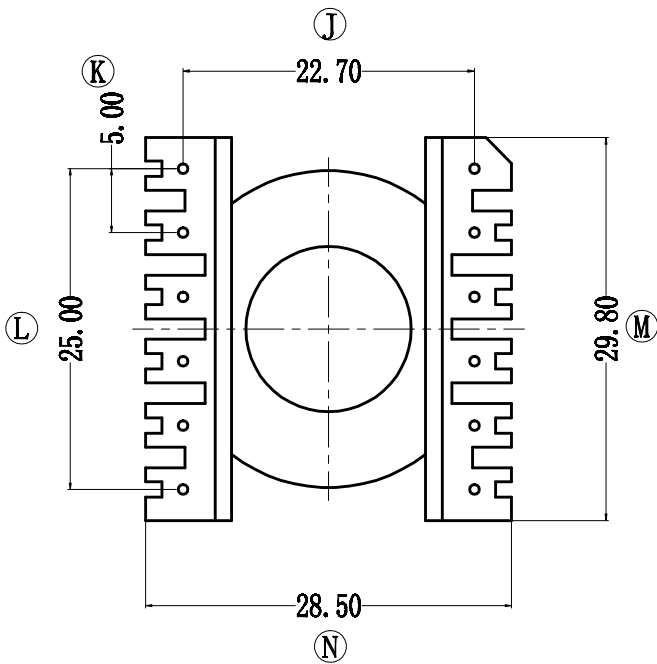
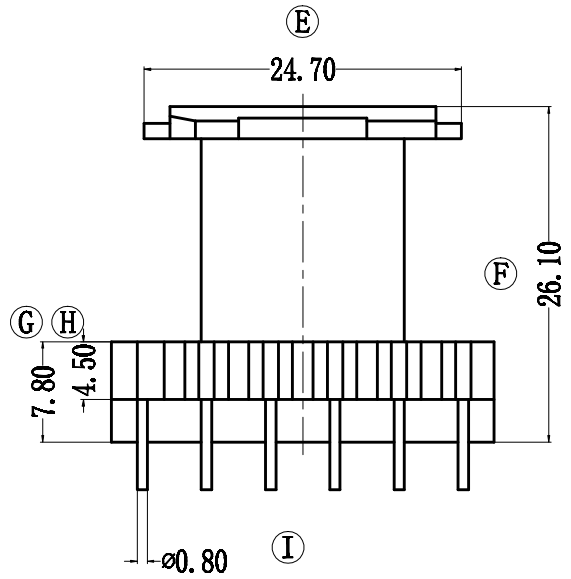
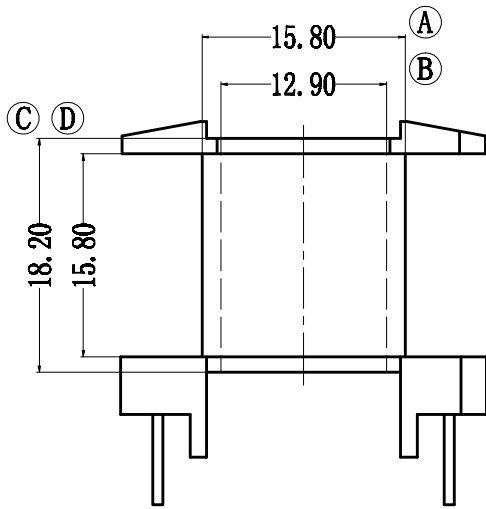

深圳市金辉鼎电子科技有限公司

地址: 深圳市公明街道将石社区油麻岗19号

0755-27658768 传真 0755-27646486

ANGLE:
+/-1°

UNIT:
mm

SCALE:
4/1



MODEL NAME:
ER33 (6+6PIN)

UL RECOGNITION:
UL 94V-0

PIN TEN LOAD:
1.0 Kg MIN

DATE:
2014/04/01

BOBBIN MATERIAL:
PHENOLIC

PIN MATERIAL:
CP WIRE

DRAWING NO:

REV:
1.0

DRAFTER

刘金

CHECKER

张威超

TOLERANCES

0<L<4 ±0.1
4<L<16 ±0.2
16<L<50 ±0.3
PIN PITCH ±0.20